

# EXTRA



## News & Promotions

Valid until 28.02.2027

# TTS98 PRO – Spaced out.

For those who want – and need – more. Compared to the TTS93 and TTS95 PRO models, the TTS98 PRO offers a 100% larger drawer volume in premium quality. A high static load-bearing capacity of 1,400 kg, a tightly welded stainless steel worktop and many other features leave no room for compromise – but all the more for tools. Including paper roll and spray can holder and all-round impact protection strips with wrap-around bumper.

## Tool trolley 98/7 A PRO

Product no. 81200169

€ 1,299.00\*

instead of € 2,435.95



7 drawers



Three-stage safety concept: Central locking with recessed cylinder lock located on the side. Together with the folding key, this provides protection against injuries and damage. The individual locking mechanism prevents unintentional opening during movement – the anti-tilt protection makes it impossible to pull out multiple drawers simultaneously.



Oil and acid-resistant smooth-running wheels (Ø 125 mm) with fibre guards to protect the bearings from dirt and fibres; with two locking brakes.

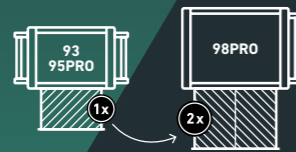

In comparison with the Model TTS93, Tool Trolley 98VA offers 100% more drawer capacity.

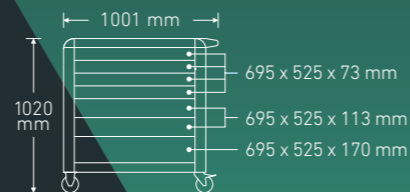
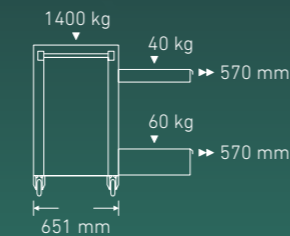

## Also available as a set!

978...

What's inside? Get all of the information here: Go to [www.stahlwille.com](http://www.stahlwille.com), enter the product number in the search field and you'll be given an overview of the entire tool range.

1

## Tool trolley 98/7 A incl. 250-piece premium tool set 98/250QR

NEW

Product no. 98830234

€ 2,869.00\*

instead of € 5,873.06



1/4" 1/2"

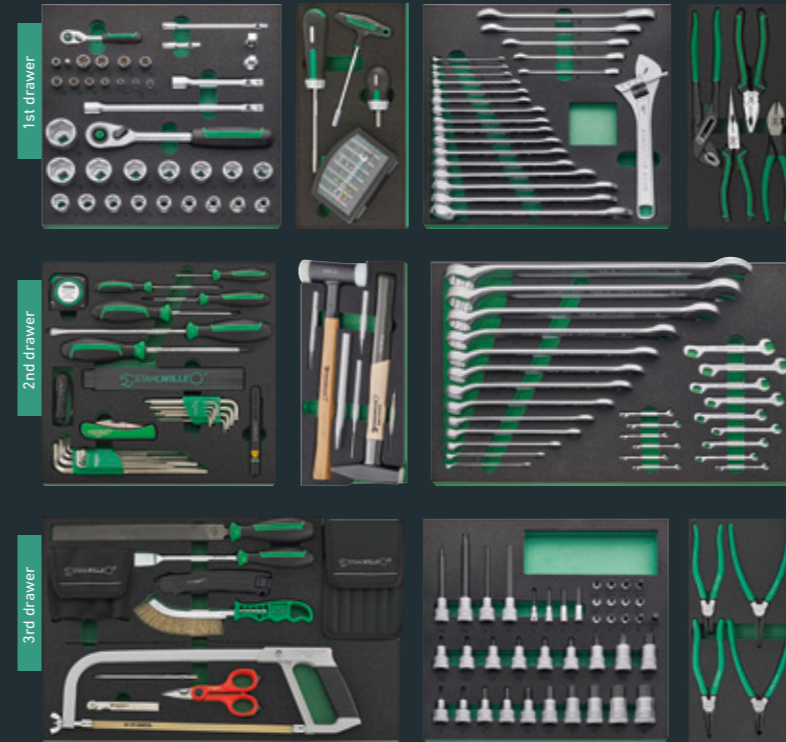

Comprehensive set for the highest demands: QR fine-tooth ratchets with extensions, sockets up to 32 mm, bit ratchet screwdrivers and bit box, screwdrivers, various pliers, and much more.



### QuickRelease

The QuickRelease safety lock prevents unintentional loss of insert tools. These click securely into place, and are only released again at the push of a button for a quick tool change.



### Customisable

Four empty drawers to store your existing tools.

MADE IN CRONENBERG  
MADE IN GERMANY

\*Recommended retail price, valid until 28.02.2027. Only for participating dealers and while stocks last.



# THE TTS95 PRO – compact and manoeuvrable tool trolley with innovative features.

The TTS95 PRO is the premium all-rounder, providing a wide range of highlights such as fully extendable drawers, a three-stage safety concept, and all-round impact protection with shock absorbers. The tightly welded and structured stainless steel worktop is particularly practical, since it is resistant to scratches and prevents liquids from penetrating into the interior of the trolley. Always handy: the paper roll and spray can holder. This model features a high static load-bearing capacity of 750 kg.

## Tool trolley 95/7 A PRO

Product no. 81200163

**€ 819.00\***  
instead of € 1,707.74



7 drawers



Three-stage safety concept: Central locking with recessed cylinder lock located on the side. Together with the folding key, this provides protection against injuries and damage. The individual locking mechanism prevents unintentional opening during movement – the anti-tilt protection makes it impossible to pull out multiple drawers simultaneously.

100%

All drawers are 100% extendable thanks to the full-extension runners. In combination with the STAHLWILLE standard TCS inserts or the variable drawer dividers, you always have a clear overview of the contents.



Oil and acid-resistant smooth-running wheels (Ø 125 mm) with fibre guards to protect the bearings from dirt and fibres; with two locking brakes.

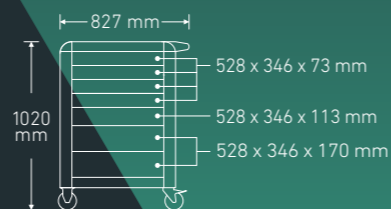
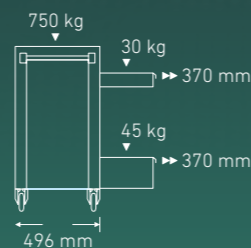

## Select your set!

1

## Tool trolley 95/8 A incl. 349-piece premium tool set 95/349QR

NEW

Product no. 98830243

**€ 3,549.00\***  
instead of € 7,517.97



8 drawers

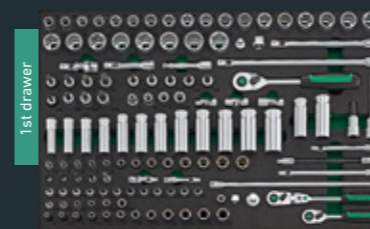

1st drawer



4th drawer



2nd drawer



5th drawer

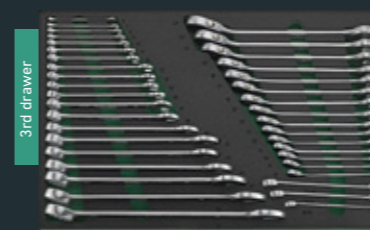

3rd drawer



6th drawer

1/4" 1/2" 3/8"

Comprehensive automotive set with finetooth ratchets, sockets up to 32 mm, measurement and test tools, screwdrivers, pliers, and much more! All foam inlays also available to order individually – see page 20 for details.

978...

What's inside? Get all of the information here: Go to [www.stahlwille.com](http://www.stahlwille.com), enter the product number in the search field and you'll be given an overview of the entire tool range.

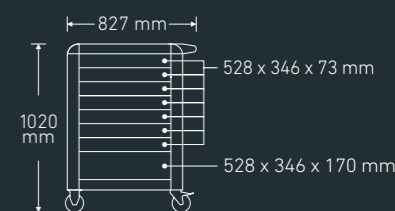
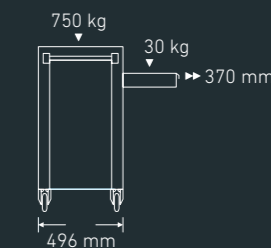

### QuickRelease

The QuickRelease safety lock prevents unintentional loss of insert tools. These click securely into place, and are only released again at the push of a button for a quick tool change.



### Customisable

Two empty drawers to store your existing tools.

MADE IN CRONENBERG  
MADE IN GERMANY

\*Recommended retail price, valid until 28.02.2027. Only for participating dealers and while stocks last.



# Select your set!

2

## Tool trolley 95/7 A incl. 250-piece premium tool set 95/250QR

Product no. 98830193

**€ 2,299.00\***  
instead of € 4,881.75



7 drawers



1/4" 1/2"



Large tool assortment for a wide range of tasks in the industrial, trade, or automotive sectors.

\*Recommended retail price, valid until 28.02.2027. Only for participating dealers and while stocks last.

3

## Tool trolley 95/8 A incl. 222-piece premium tool set 95/222QR

Product no. 98830244

**€ 2,049.00\***  
instead of € 4,241.00



8 drawers



1/4" 1/2"

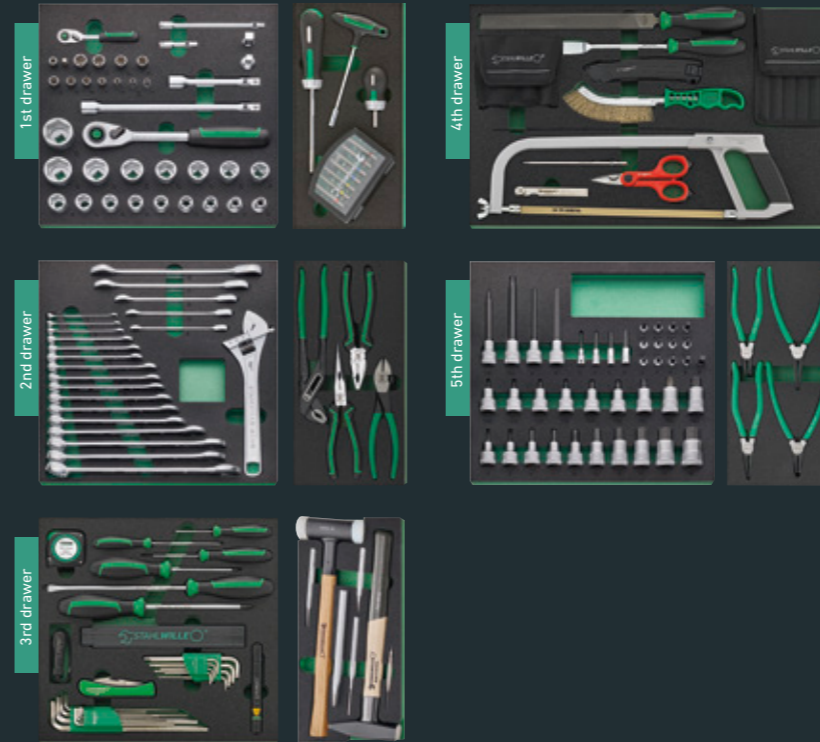

Tool set with comprehensive equipment for industrial applications: QR fine-tooth ratchets with extensions, a variety of sockets and screwdriver sockets, and much more.

Three empty drawers provide enough storage space for your existing tools.

4

## Tool trolley 95/7 A incl. 157-piece premium tool set 95/157QR

Product no. 98830192

**€ 1,649.00\***  
instead of € 3,384.46



7 drawers



1/4" 1/2"

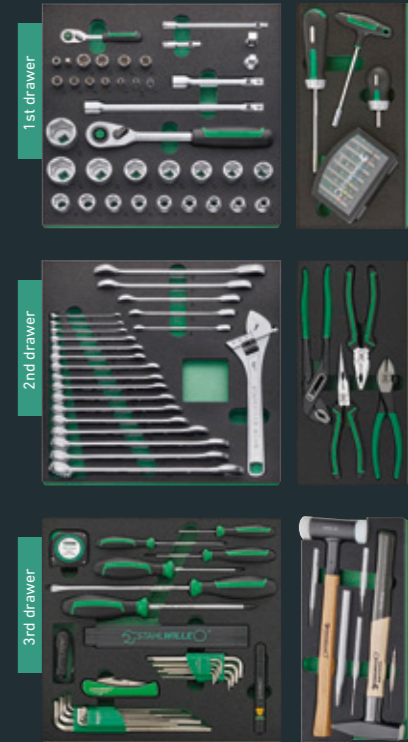

Tool set for a wide range of applications, also ideal for industrial use: QR fine-tooth ratchets with extensions, sockets up to 32 mm, bit ratchet screwdrivers and bit box, screwdrivers, various pliers, and much more.

Four empty drawers provide enough storage space for your existing tools.

978...

What's inside? Get all of the information here: Go to [www.stahlwille.com](http://www.stahlwille.com), enter the product number in the search field and you'll be given an overview of the entire tool range.

MADE IN CRONENBERG  
MADE IN GERMANY



# MADE FROM STEEL. BUILT TO LAST.

## The TTS95 PRO NDE: cool design, tough finish.

For those who don't just do a job, but accept a challenge. Those who build something. Those with a style of their own. The TTS95 PRO featuring the new **Best tools never die design** with high-quality UV coating. With ready-configured tool sets for different requirements – plus a stylish beanie and cool sticker sheet.

### Tool trolley 95/7 PRO NDE

Product no. 81200175

€ 819.00\*

instead of € 1,738.64

1 **NDE Ultra set including a 250-piece tool set – for the real professionals.**  
95/250QR NDE

Product no. 98830241

€ 2,299.00\*

instead of € 5,175.75



1/4" 1/2"



1st drawer



4th drawer



2nd drawer

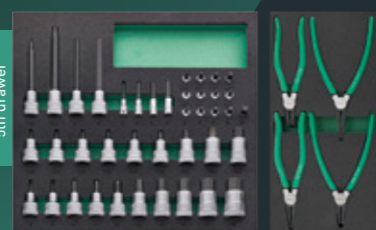

5th drawer



3rd drawer



6th drawer



**Upgrade included!**  
Cool tool set. Cool upgrade.  
Sticker sheet and stylish beanie.

2 **NDE Max set including a 157-piece tool set – ready for just about any job.**  
95/157QR NDE

Product no. 98830241

€ 1,649.00\*

instead of € 3,591.61



1/4" 1/2"



1st drawer



4th drawer



2nd drawer



5th drawer



3rd drawer



6th drawer

# THE TTS93 – perfect configuration at an impressive price.

Regardless of whether it is purchased alone or complete with one of our two premium tool sets, the STAHLWILLE TTS93 is the perfect partner for trade and industry alike. Includes many practical features and it comes at an impressive price.

### Tool trolley 93/6 A

Product no. 81200154

€ 689.00\*

instead of € 1,211.74

1 **TTS 93/6 set incl. 157-piece premium tool set**  
93/157QR

Product no. 98830178

€ 1,499.00\*

instead of € 3,065.19



1/4" 1/2"



1st drawer



4th drawer



2nd drawer

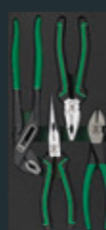

5th drawer



3rd drawer

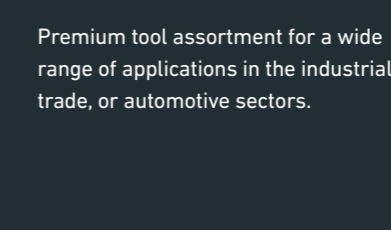

6th drawer

Premium tool assortment for a wide range of applications in the industrial, trade, or automotive sectors.



6 drawers

2 **TTS 93/6 set incl. 130-piece premium tool set**  
93/130

Product no. 98830177

€ 1,219.00\*

instead of € 2,423.49



1/4" 1/2"



1st drawer



4th drawer



2nd drawer



5th drawer

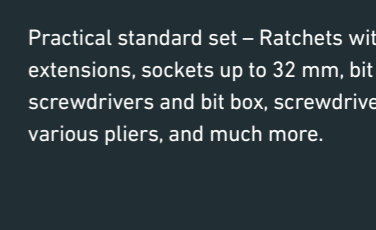

3rd drawer

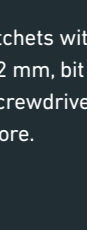

6th drawer

Practical standard set – Ratchets with extensions, sockets up to 32 mm, bit ratchet screwdrivers and bit box, screwdrivers, various pliers, and much more.

978...

What's inside? Get all of the information here: Go to [www.stahlwille.com](http://www.stahlwille.com), enter the product number in the search field and you'll be given an overview of the entire tool range.

MADE IN CRONENBERG  
MADE IN GERMANY



# THE WORKBENCH WB 630 – High performance meets powerful features!

The BIG one! The WB 630 not only has a particularly sturdy design, but with a width of 200 cm it also offers a particularly large work surface. It also impresses with a comprehensive range of features that make it the perfect partner for work in trade and industry.

## Workbench WB 630

Product no. 85010630

**€ 899.00\***  
instead of € 1.636.67



Incl. holder for TOP BOX – optional extra.

Height adjustable in 25 mm increments.

**1000 kg**

With a static load bearing capacity of 1,000 kg and a 3 cm thick, FSC-certified wooden top with a width of 200 cm of rubberwood, the WB 630 is also ideal for the 'heavy jobs'. The individual height adjustment ensures back-friendly work. This means that workshop trolleys do not fit under the workbench.



The WB 630 simply offers more. No matter whether perforated rear panel for attaching tools, spray can and paper roll holders, EU triple socket with two USB ports, two rubberised cable grommets, height adjustment in 25 mm increments on the legs (up to 30.5 cm) or levelling feet for precise alignment of the workbench. Everything is included here.



The lockable drawer with internal dimensions of 530 x 350 x 74.5 mm for sufficient space and is TCS-compliant. Thanks to the telescopic full-extension runner with ball cage guide it can be pulled out smoothly and completely – for maximum convenience and quick access. The drawer can be mounted on the left or right, as can the TOP BOX bracket.



Stationary or mobile tool storage? Simply both. The workbench offers an integrated holder that can be installed on the left or right holder for the optional STAHLWILLE TOP BOX. With plenty of space for tools; available separately.

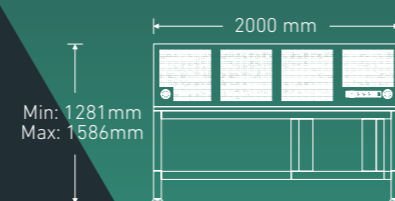
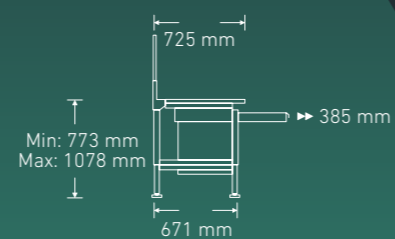

# TOP BOX AND WHEEL SET – available separately. For even more flexibility.

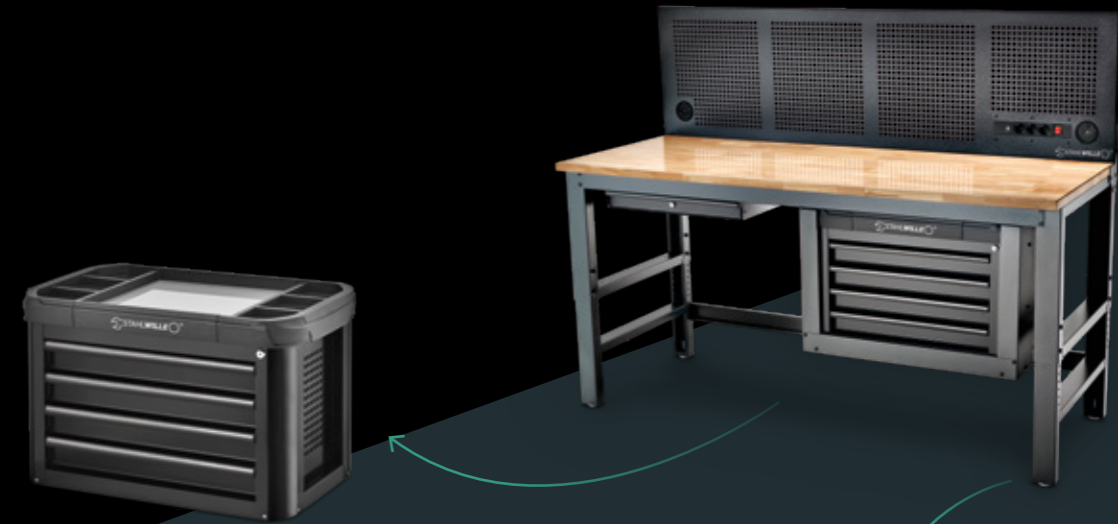

## Tool box 93 TOP BOX

Product no. 81200157

**€ 449.00\***  
instead of € 753.46

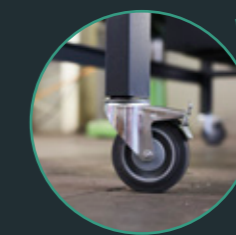
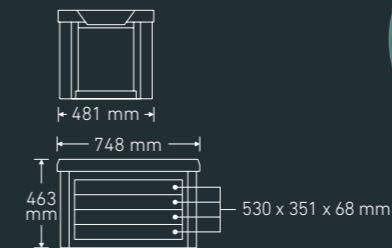

## Set of wheels R 630

4 swivelling and smooth-running castors (Ø 125 mm) for the WB630 workbench, with locking brakes.  
Product no. 81490007

**€ 99.00\***  
instead of € 181.28

## Service trolley 612 ST

Service trolley (without tools)

- Rubberized wheels (Ø 125 mm) and two parking brakes ensure ease of movement
- Perfectly equipped with a drawer and two shelves
- High static load bearing capacity of 150 kg

Product no. 81300612

**€ 189.00\***  
instead of € 340.88

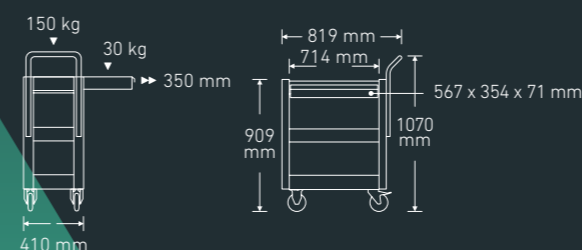

\*Recommended retail price, valid until 28.02.2027. Only for participating dealers and while stocks last.



# THE WB625 WORKBENCH – Think big! 115 cm of room for lots of premium tools!

With its seven extra-wide drawers, our new workbench WB625 provides a maximum amount of storage space and is also extremely durable. Particularly comfortable: the birch multiplex worktop with a working height of 104 cm. Includes an individually adjustable paper roll holder for paper rolls up to 30 cm wide.

Premium tool sets with tools for high force transmission: 1/2" QR fine-tooth ratchet, sockets up to 32 mm, circlip pliers, various screwdrivers, etc.

## Workbench WB 625

Product no. 85010625

**€ 1,319.00\***

instead of € 2,410.20



**104  
cm**



Only from STAHLWILLE: Worktop height of 104 cm for comfortable working. The sturdy construction and the birch multiplex worktop provide the durability that is typical of STAHLWILLE.

Oil and acid-resistant smooth-running wheels (Ø 125 mm) with fibre guards to protect the bearings from dirt and fibres; with two locking brakes.



Three-stage safety concept: Central locking with recessed cylinder lock located on the side. Together with the folding key, this provides protection against injuries and damage. The individual locking mechanism prevents unintentional opening during movement – the anti-tilt protection makes it impossible to pull out multiple drawers simultaneously.

**XXL**

Everything in XXL. The seven removable drawers with full extension and a width of 880 mm provide lots of storage space. The multiplex worktop is not only extremely large (1150 x 500 x 30 mm), but is also FSC-certified.

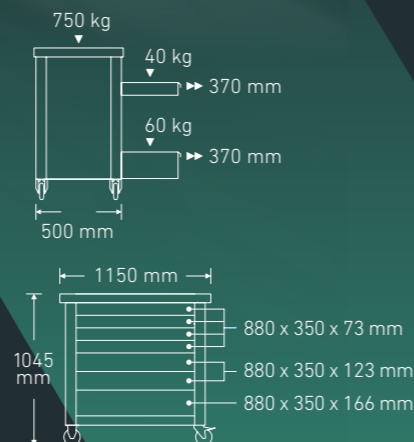

## Select your set!

978...

What's inside? Get all of the information here: Go to [www.stahlwille.com](http://www.stahlwille.com), enter the product number in the search field and you'll be given an overview of the entire tool range.

### 1 WB 625 set incl. 267-piece premium tool set WB 625/267QR

Product no. 98830181

**€ 2,969.00\***

instead of € 6,068.99

### 2 WB 625 set incl. 161-piece premium tool set WB 625/161QR

Product no. 98830179

**€ 2,319.00\***

instead of € 4,337.78



MADE IN CRONENBERG  
MADE IN GERMANY

\*Recommended retail price, valid until 28.02.2027. Only for participating dealers and while stocks last.

## TOOL SET – Hard-wearing and always to hand.

STAHLWILLE tool boxes are exceptionally durable thanks to their ABS plastic and aluminium frame with impact edge protection, and provide plenty of room and a clear overview.

978...

What's inside? Get all of the information here: Go to [www.stahlwille.com](http://www.stahlwille.com), enter the product number in the search field and you'll be given an overview of the entire tool range.

### Tool box empty



with trolley function



13302/TR

Tool box 13302/TR, empty  
Product no. 81620010

€ 249.00\*

instead of € 462.27



13301

Tool box 13301, empty  
Product no. 81620009

€ 139.00\*

instead of € 263.69

### Tool box with 87-piece premium tool set

Ideal for use in the trade sector and for working on live electrical parts.



with trolley function

13302/TR/87

Tool box 13302 including an 87-piece premium tool set.  
Product no. 98830185

€ 749.00\*

instead of € 1,653.38



13301/87

Tool box 13301 including an 87-piece premium tool set.  
Product no. 98830183

€ 649.00\*

instead of € 1,464.71

## THE WB 621 WORKBENCH – the all-rounder with the perfect working height.

The unique layout with two XXL drawers, an additional five drawers and the locker section provides maximum flexibility in terms of loading, and makes the WB 621 the ideal partner for tool storage for tradespeople and industry alike. Includes an individually adjustable paper roll holder for paper rolls up to 30 cm wide.

### Workbench WB 621

Product no. 85010621

€ 1,319.00\*

instead of € 2,448.31



The locker section features a height-adjustable shelf (adjustable in 7 cm increments), two rubberised cable outlets, and a removeable cable duct on the back.



Oil and acid-resistant smooth-running wheels (Ø 125 mm) with fibre guards to protect the bearings from dirt and fibres; with two locking brakes.



Three-stage safety concept: Central locking with recessed cylinder lock located on the side. Together with the folding key, this provides protection against injuries and damage. The individual locking mechanism prevents unintentional opening during movement – the anti-tilt protection makes it impossible to pull out multiple drawers simultaneously.



Only from STAHLWILLE: Worktop height of 104 cm for comfortable working. The sturdy construction and the multiplex worktop provide the durability that is typical of STAHLWILLE.

Also available in combination with three different tool sets. More information on pages 16 and 17.

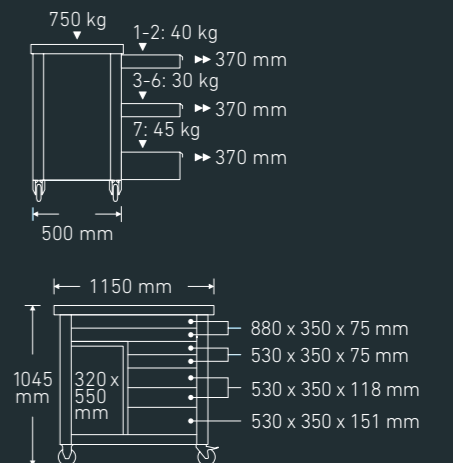
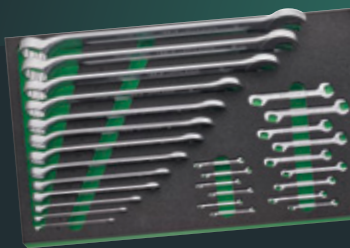

# Select your set!

The STAHLWILLE WB 621 workbench offers three sets with different premium tool assortments – all well thought out and perfectly suited for numerous applications in industry and trades. These include the 238-piece premium tool assortment for use in the agricultural sector and for service work on construction machinery and commercial vehicles.



16 **WB 621 set incl. 238-piece premium tool set WB 621/238 QR**

Product no. 98830204

**€ 3,469.00\***  
instead of € 6,835.75



This set is specially designed for repairing and maintaining agricultural and construction machinery.

1/4" 1/2"

2 **WB 621 set incl. 267-piece premium tool set WB 621/267QR**

Product no. 98830195

**€ 2,969.00\***  
instead of € 6,107.44

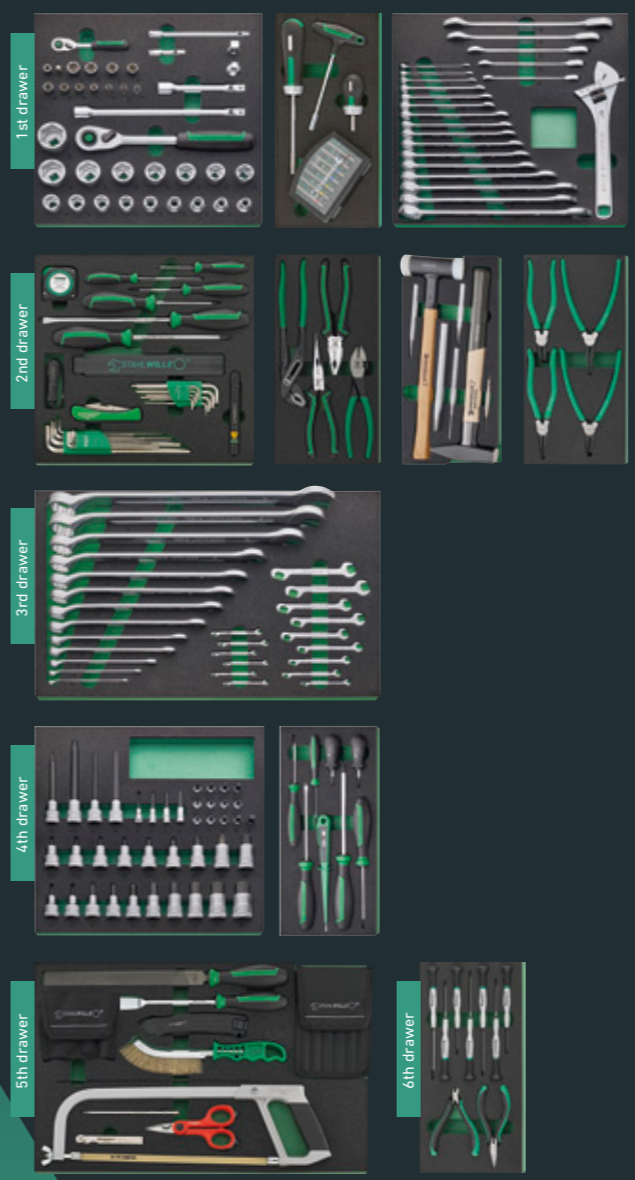

1/4" 1/2"

3 **WB 621 set incl. 161-piece premium tool set WB 621/161QR**

Product no. 98830194

**€ 2,319.00\***  
instead of € 4,376.22

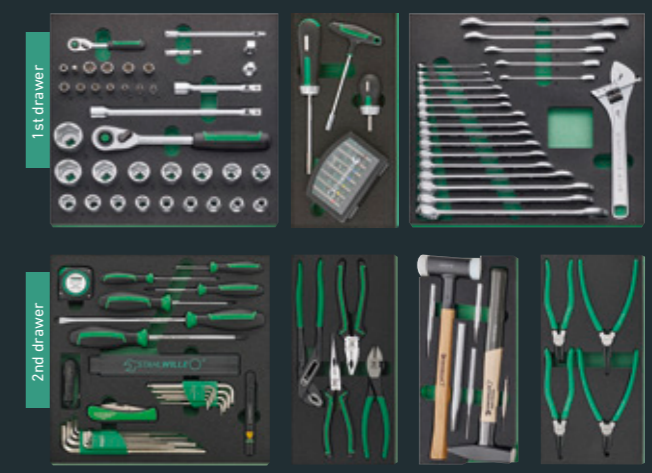

1/4" 1/2"

978...  
What's inside? Get all of the information here: Go to [www.stahlwille.com](http://www.stahlwille.com), enter the product number in the search field and you'll be given an overview of the entire tool range.



**QuickRelease**

The QuickRelease safety lock prevents unintentional loss of insert tools. These click securely into place, and are only released again at the push of a button for a quick tool change.

MADE IN CROENBERG  
MADE IN GERMANY

\*Recommended retail price, valid until 28.02.2027. Only for participating dealers and while stocks last.



# TCS SETS – Premium tools. Perfectly sorted. Perfectly protected.



L

**€ 310.00\***  
instead of € 594.74

TCS set 1/2" + 1/4" QR socket set, 38-pcs.

**TCS 1 821/38**

Product no. 96830264



L

**€ 238.00\***  
instead of € 450.72

TCS set of spanners, 22-pcs.

**TCS 4 821/22**

Product no. 96830267



M

**€ 99.90\***  
instead of € 191.66

TCS set of bits, 59-pcs.

**TCS 2 821/59**

Product no. 96830265



M

**€ 99.90\***  
instead of € 197.47

TCS set of striking tools, 7-pcs.

**TCS 6 821/7**

Product no. 96830269



M

**€ 99.90\***  
instead of € 193.98

TCS set of pliers, 4-pcs.

**TCS 3 821/4**

Product no. 96830266



M

**€ 79.00\***  
instead of € 148.70

TCS set of circlip pliers, 4-pcs.

**TCS 10 821/4**

Product no. 96830273

## TCS inlay system

XL

L

M



TTS93

Per drawer

1 x

XL

or

1 x + 1 x

L M

or

3 x

M M M



WB625

Per drawer

1 x + 1 x

XL L

or

1 x + 1 x + 2 x

L M M M

or

3 x + 2 x

M M M M M



XL

**€ 259.00\***  
instead of € 513.43

TCS set of spanners, 28-pcs.

**TCS 9 821/28**

Product no. 96830272



XL

**€ 175.00\***  
instead of € 332.22

TCS set of files, 21-pcs.

**TCS 8 821/21**

Product no. 96830271

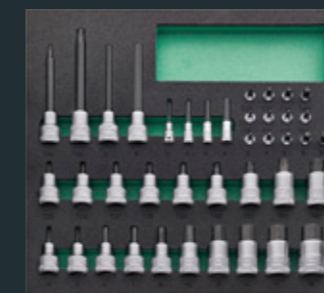

L

**€ 299.00\***  
instead of € 607.54

TCS set of sockets, 40-pcs.

**TCS 11 821/40**

Product no. 96830274



L

**€ 157.00\***  
instead of € 300.31

TCS set of screwdrivers, 27-pcs.

**TCS 5 821/27**

Product no. 96830268



M

**€ 89.00\***  
instead of € 153.34

TCS set of electronic screwdrivers, 9-pcs..

**TCS 7 821/9**

Product no. 96830270



M

**€ 66.00\***  
instead of € 126.62

TCS set of screwdrivers, 8-pcs.

**TCS 12 821/8**

Product no. 96830275

MADE IN CROENBERG  
MADE IN GERMANY

\*Recommended retail price, valid until 28.02.2027. Only for participating dealers and while stocks last.



# TCS SETS – Premium tools. Perfectly sorted. Perfectly protected.

**NEW** All TCS sets shown on this double-page spread are new.

**Comprehensive automotive set**  
see page 5. All TCS foam inlays are also available to order individually.

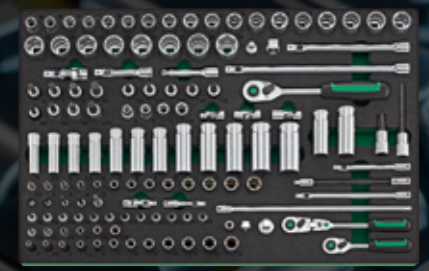

XL  
**€ 949.00\***  
instead of € 1.906.53

TCS set of QR ratchets, sockets, and screwdriver sockets 1/4" + 3/8"  
**TCS 1 SET 349QR**  
Product no. 96830303



XL  
**€ 579.00\***  
instead of € 1.156.69

TCS set QR ratchets, sockets, and screwdriver sockets 1/2"  
**TCS 2 SET 349QR**  
Product no. 96830304

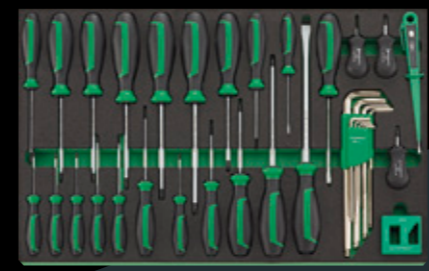

XL  
**€ 219.00\***  
instead of € 439.00

TCS set screwdrivers and L-Keys, magnetiser  
**TCS 4621-4650/35**  
Product no. 96830309



L  
**€ 149.00\***  
instead of € 277.59

TCS set electronic screwdriver set  
**TCS 4751-4754/8/3/4/8**  
Product no. 96830293



XL  
**€ 259.00\***  
instead of € 499.55

TCS set DRALL+ screwdrivers  
**TCS 3 SET 349QR**  
Product no. 96830305



XL  
**€ 299.00\***  
instead of € 590.19

TCS set pliers, plastic scrapers, L-Keys, light  
**TCS 4 SET 349QR**  
Product no. 96830306



XL  
**€ 189.00\***  
instead of € 362.00

TCS set hook tools, claw lifter, magnetic lifter, light  
**TCS 10503-13134/13**  
Product no. 96830310



M  
**€ 219.00\***  
instead of € 422.84

TCS set QuickRelease socket set 3/8"  
**TCS 456/16/7QR 3/8"**  
Product no. 96830370

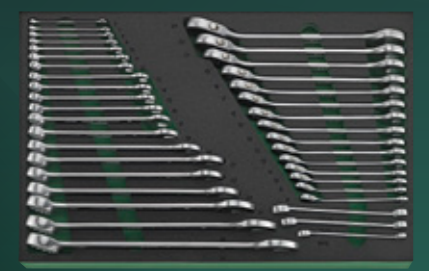

XL  
**€ 579.00\***  
instead of € 1.153.60

TCS set spanners, ring jaw, double jaw, combination ratchet  
**TCS 5 SET 349QR**  
Product no. 96830307



XL  
**€ 315.00\***  
instead of € 615.94

TCS set hammers, pin punches, chisels, and special automotive tools  
**TCS 6 SET 349QR**  
Product no. 96830308



### Modular Inlay System

This flexible solution for tool storage makes it possible to customise your tool trolleys and workbenches with 1/6, 1/3, 2/3 or 3/3 foam inlays.



### Tool Control System

The intelligent modular inlay system protects and organises the tools in tool boxes, tool trolleys and workbenches. Two-colour foam inlays make checking the completeness of the tools quick and easy.

\*Recommended retail price, valid until 28.02.2027. Only for participating dealers and while stocks last.

MADE IN CROENBERG  
MADE IN GERMANY



# MOBILE TOOL STORAGE – High-quality professional tools – perfectly organised, always to hand.

## Tool trolley incl. 160-piece tool set 13230 WT/TS

Tool trolley 13217 with a 160-piece premium tool assortment.

- Ideal for professional installations in industrial environments
- Extremely sturdy and resilient tool trolley with extendible telescopic handle
- 5 easily removed lockable drawers with pull-out stop and transparent lid
- With Tool Control System TCS for visually checking the tools are all present and correct
- Lockable in 3 places with a padlock
- Lockable with key, 2 keys included

Product no. 98814924

**€ 1,479.00\***

instead of € 3,090.47



with trolley function

Practical organisation: Lid compartment and 4 drawers contain the 160-piece tool set, the lower drawer (with a height of 60 mm) is empty for your own customisation.

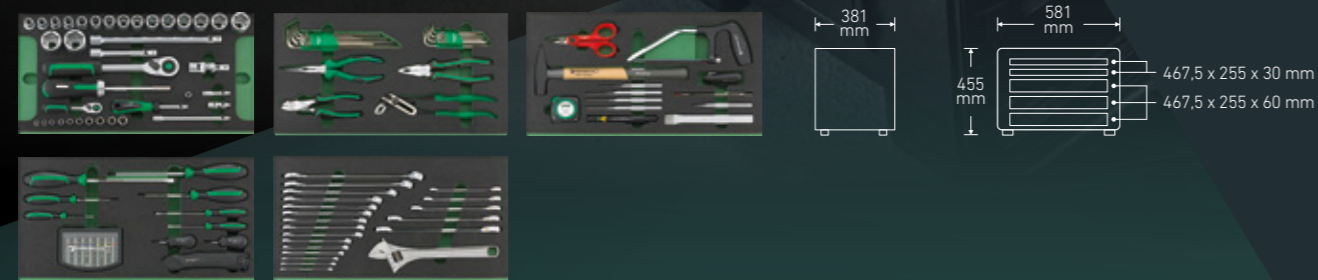

## Top case 13261 TS

**NEW**

- Handy extension to tool trolley 13217 (as of 2025 model, with suitable lid) for additional storage space.
- The patented LOCK-UNLOCK system allows the 13261 TS to be fastened quickly, easily, and securely with just a single action.

Product no. 81091336

**€ 99.00\***

instead of € 218.36



## Tool trolley incl. 89-piece tool set 13239 WT/LGE

**NEW**

More than just standard. The extended, 89-piece basic set with premium tools – for the most exacting requirements.

- Robust and durable tool trolley for professional use
- 1 removable tray with 2 handles and 2 transparent drawer lids under the top cover
- 5 easily removable, lockable drawers with transparent lids with pull-out stop
- Extendable telescopic handle for easy transport
- 2 side handles
- Resistant to Skydrol, acetone, petrol, and hydraulic oils
- Lockable in 3 places with a padlock
- Lockable with key, 2 keys included

Product no. 98814927

**€ 1,199.00\***

instead of € 2,549.00

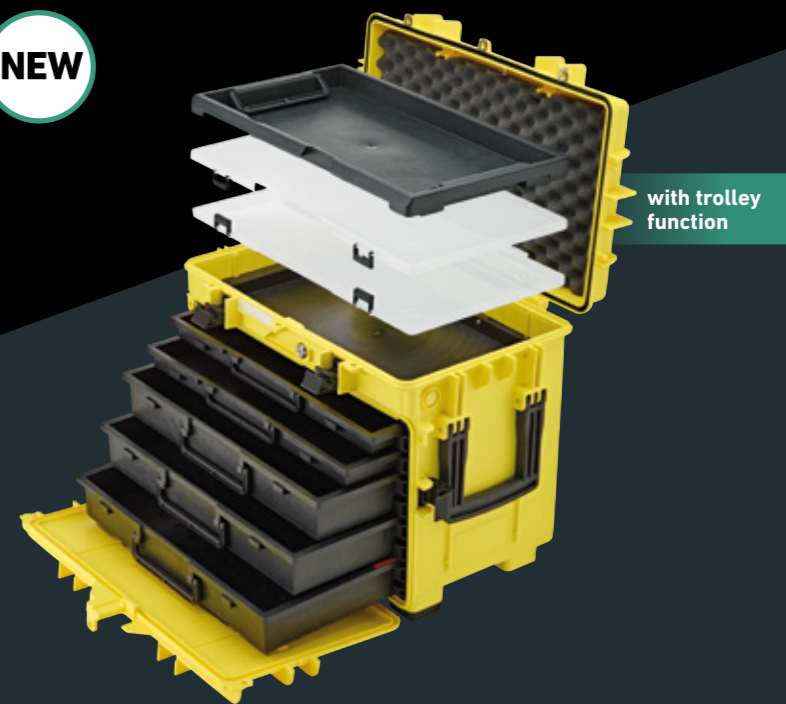

with trolley function



## Tool trolley 13217/5 LGE

Tool trolley without tools. The tool trolley 13217, made of sturdy polypropylene, can be equipped to suit the user's needs, and can hold up to 60 kg. A reliable piece of equipment in the workshop or assembly area – ideally suited for mechanics, machine setters, fitters, and technicians, for example.

Product no. 96132175

**€ 439.00\***

instead of € 896.00



## TORQUE WRENCH – precision made in Cronenberg.

## SEVENFIVEZERO – Pared back to the essentials. Designed for precision work.

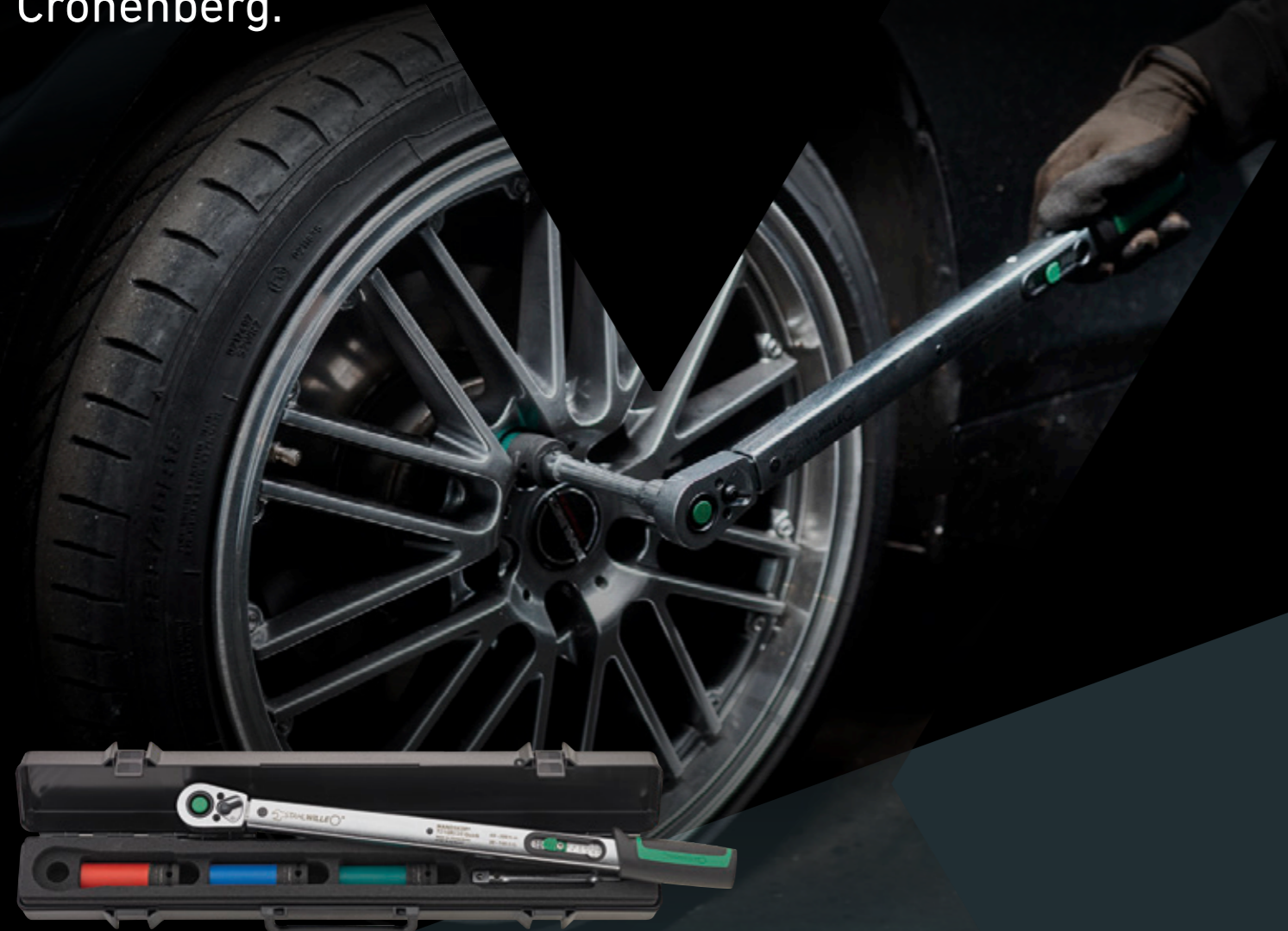

### Torque wrench 750NR

The 750NR is built with robust STAHLWILLE quality and a precision spring mechanism that delivers a clearly audible and noticeable click – for reliable bolted joints. Clicking torque wrench with dual stop signal and permanently installed, reversible fine-tooth ratchet (60 teeth). Resilient, long-lasting spring mechanism (toggle lever). Fast, precise adjustment with QuickSelect quick adjustment.

For maximum long-term measurement accuracy and long service life, we recommend resetting the wrench to '0' after use.



750NR torque wrench

Model	Product no.	N·m	ft·lb	■*	⊖ g	EXTRA price excl. VAT	EXTRA price including VAT
750NR/100	50021003	20–100	15–74	3/8	1,150	139.00	280.16
750NR/200	50021004	40–200	30–150	1/2	1,460	149.00	300.31
750NR/400	50021006	80–400	60–300	3/4	2,550	219.00	396.75

### Wheel-change set 721QR/20/3/1 Quick

The 5-piece wheel change set comes in a sturdy and practical plastic case that accommodates all of the most important tools for changing a wheel in one set.

- Torque wrench with a measuring range of 40–200 N·m
- Permanently installed 1/2" ratchet and QuickRelease safety lock
- Special plastic coating protects the alloy wheels, wheel bolts and wheel nuts
- Colour-coded to make it quicker to find the right size

Product no. 96507214

**€ 299.00\***

instead of € 645.41



### 1/2" IMPACT socket set 51IMP K/3

3-piece wheel nut socket set with colour coded plastic sleeves, gentle on rims, in plastic case. Contents: 17 mm (green); 19 mm (blue); 21 mm (red). Product no. 96838103

**€ 36.90\***

instead of € 74.04



#### No resetting to "0"

Unlike conventional torque wrenches, resetting to "0" to release the spring is not necessary.



### Wheel change set 750NR/200/3/1

5-piece wheel change set in a robust and practical plastic box, consisting of a torque wrench with permanently installed fine-tooth ratchet, an extension, and three colour-coded sockets (1/2") in the popular sizes of 17 mm (green), 19 mm (blue), and 21 mm (red).

750NR/200/3/1

Product no.	N·m	ft·lb	■*	L mm	b mm	h mm	No. of pcs.	⊖ g
96507216	40–200	30–150	1/2	680	81	66	5	2940

**€ 199.00\***

instead of € 389.87

MADE IN CRONENBERG  
MADE IN GERMANY

\*Recommended retail price, valid until 28.02.2027. Only for participating dealers and while stocks last.



## PIPE TORQUE WRENCH – Precise and robust.

### Pipe torque wrench 721/30Q 18" HD & 730/20Q 14" HD

NEW

Robust torque wrench with permanently fitted STILLSON pipe wrench for precise working on bolted joints on pipes or hydraulic connections, for example.

- Lightning-fast and precise torque adjustment
- Click with dual stop signal
- No reset to '0' required
- The measuring element is only under load when a force is applied
- 721/30Q 18" HD: 5 selectable torque values: 180; 220; 270; 300; 350 N·m
- 730/20Q 14" HD: 7 selectable torque values: 40; 80; 120; 150; 180; 220; 270 N·m



721/30Q 18" HD  
Product no. 50184102

€ 379,00\*  
instead of € 714,31

730/20Q 14" HD  
Product no. 50184101

€ 259.00\*  
instead of € 483.39

## RATCHETS – specially designed for heavy loads and efficient working. Whilst maintaining reliability.

### Telescopic ratchet 1/2" 516

- 5-fold adjustable shaft, 410, 465, 520, 575 and 630 mm
  - Robust 36-tooth ratchet drive, Working angle 10°
  - Maintenance-free, durable slide bearing
- Product no. 13160000

€ 86.90\*  
instead of € 155.49

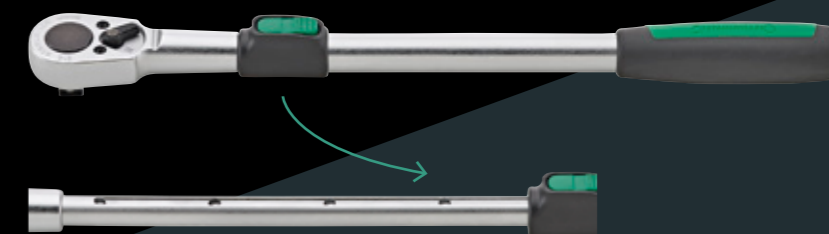

5 adjustable locking positions



The length can be adjusted conveniently and even with one hand in 55 mm increments (410 mm, 465 mm, 520 mm, 575 mm and 630 mm) using the rocker switch.



The robust ratchet has 36 teeth, and is manufactured in accordance with DIN 3122/ISO 3315.



The extension operates using maintenance-free slide bearings and stop protection, operates quickly and safely and is extremely durable.



The clockwise and counter-clockwise change-over switch is slightly recessed. This avoids accidental switching during use.

### Ratchet set 1/4" + 1/2" 415QR/512QR

2-piece QuickRelease fine tooth ratchet set with 1/4" and 1/2" drive.

- Eighty teeth provide a ratchet angle of only 4.5° – facilitating efficient working in confined spaces.
- STAHLWILLE QuickRelease is the only locking system that locks every single item in the tool chain - from the ratchet, the extension, universal joints to the socket.

Product no. 91336421

€ 99.90\*  
instead of € 196.08



MADE IN CRONENBERG  
MADE IN GERMANY



**SPANNER** – lightweight meets robust high performance steel and comfortable rounded finish.



Ring side 15°  
angled and  
reversible



**Ratchet combination spanner set**  
17/15

15-piece set, contents: 8; 9; 10; 11; 12; 13; 14; 15; 16; 17; 18; 19; 21; 22; 24 mm  
Product no. 96411715

**€ 279.00\***  
instead of € 607.08



**Ratchet combination spanner set**  
17/12

12-piece set, contents: 8; 9; 10; 11; 12; 13; 14; 15; 16; 17; 18; 19 mm  
Product no. 96411712

**€ 185.00\***  
instead of € 358.77



**Ratchet combination spanner set**  
17/5

5-piece set, contents: 8; 10; 13; 17; 19 mm  
Product no. 96411705

**€ 81.90\***  
instead of € 150.80



**Set of combination spanners**  
14/11

11-piece set, contents: 6; 7; 8; 9; 10; 11; 12; 13; 17; 19; 22; 24; 27; 30; 32 mm  
Product no. 96401006

**€ 93.90\***  
instead of € 175.13



**Set of combination spanners**  
13/15

15-piece set, contents: 6; 7; 8; 9; 10; 11; 12; 13; 17; 19; 22; 24; 27; 30; 32 mm  
Product no. 96400803

**€ 164.00\***  
instead of € 317.41



**Double open-ended spanner sets**  
10/8

8-piece set, contents: 6 x 7; 8 x 9; 10 x 11; 12 x 13; 14 x 15; 16 x 17; 18 x 19; 20 x 22 mm  
Product no. 96400305

**€ 44.90\***  
instead of € 76.68

**PRACTICAL HELPERS** – versatile, smart, and always right where you need them. These are the little (and big!) tools for making your everyday work easier.



**Magnetiser**  
680 M

The powerful magnet allows steel blades and blade-like tools to be quickly and reliably magnetised or demagnetised. Easy to use – ideal for the workshop and assembly area.  
Product no. 77270680

**€ 5.90\***  
instead of € 8.03



**Bit box**  
1206

56-piece bit box with many drive profiles and sizes for professional use.  
Product no. 96080156

**€ 44.00\***  
instead of € 89.47



**Screwdriver set**  
4687

5-piece screwdriver set – in a practical assortment of different drives (slotted and Philips).  
Product no. 96469113

**€ 24.50\***  
instead of € 50.57



**Plastic scraper set**  
10682/5

5-piece plastic scraper set for damage-free removal of seals, sealants, and residue.  
— Made from fiberglass reinforced plastic  
— Different blade shapes and widths  
— Signal colour bright green  
— In a practical textile case  
Product no. 96722700

**€ 42.90\***  
instead of € 88.45



**Folding ruler**  
13112

With its deeply embossed dual scale in centimetres and millimetres, this reliable professional ruler offers optimum readability, making it ideal for the trade sector, and DIY projects. Each link has a dual 180° angle indicator for precise alignment.  
Product no. 77470003

**€ 6.95\***  
instead of € 10.70



**Bottle opener**  
STAHLWILLE

The STAHLWILLE bottle opener is a high-quality tool 'Made in Germany' that combines functionality with classic design. Thanks to its ergonomic shape it can remove any bottle cap effortlessly and with a secure grip, making it an indispensable everyday tool.  
Product no. 77301020

**€ 7.90\***  
instead of € 13.80



# BRIGHT PROSPECTS – lighting for maximum safety and comfort.



## Duo spotlight 13139 DL 11500

Powerful, rechargeable work spotlight for optimal illumination of the workspace.

- intense brightness of up to 11,500 lm
- 3 brightness levels: 100 % (11,500 lm), 50 % (5,750 lm), 20 % (2,000 lm)
- runtime up to 1.5 h (11,500 lm), 3 h (5,750 lm), 6 h (2,000 lm)
- 2 colour temperatures (4,000K and 6,500K)
- 2 fold-out LED modules that can be rotated 180° independently of each other
- 2 hooks that can be rotated 90° for hanging
- light detachable from stand
- height-adjustable stand: 1,171-1,980 mm, with handle, cable reel and ground spikes
- 4 magnets in the base for attachment to metallic surfaces
- with powerbank function
- battery and mains operation
- protection class: IPX4/IK07
- weight: 5,960 g

Product no. 77490020

**€ 259.00\***

instead of € 512.94

## Hand light 13138 HL 1000

Practical, rechargeable hand light for universal use.

- up to 1,000 lm and 35 m range
- 2 brightness levels: 100 % (1,000 lm), 50 % (380 lm)
- additional top LED in the lamp head with 180 lm and 60 m illumination range
- runtime up to 2.5 h (1,000 lm), 4.5 h (380 lm), 7 h (180 lm)
- flexible fastening options: Magnets on the underside and rear, as well as 2 hooks that can rotate 360°
- swivelling stand (90°)
- compact and handy: 266 x 48 x 32 mm
- USB-C charging cable (100 cm) included
- charging time: approx. 4 hours
- with charge control and remaining capacity display
- protection class: IP54/IK07
- weight: 340 g

Product no. 77490019

**€ 55.90\***

instead of € 100.94



## Headlamp 13137 KL 450

Rechargeable headlamp for full freedom of movement and precise work.

- light strip with up to 450 lm and 33 m range
- 3 brightness levels: 100 % (450 lm), 25 % (110 lm), 8 lm (red)
- switchable LED spotlight with 60 lm and 45 m illumination range
- runtime up to 1.5 h (450 lm), 4 h (110 lm), 12 h (8 lm), 9.5 h (60 lm)
- with practical gesture sensor for switching on and off
- elastic, adjustable headband for a secure and comfortable fit
- USB-C charging cable (30 cm) included
- charging time approx. 2.5 hours
- protection class: IP20/IK03
- weight: 100 g

Product no. 77490018

**€ 17.90\***

instead of € 30.75



## Penlight 13136 SL

Convenient, rechargeable LED pen light for versatile use.

- with 500 lm (up to 850 lm in short boost mode) and range of 64 m
- 3 brightness levels: 100 % (500 lm), 50 % (250 lm), boost (850 lm)
- runtime up to 1.5 h (500 lm), 3 h (250 lm)
- adjustable focus by rotation of the lamp head
- sturdy aluminium body
- handy pen format with practical clip
- USB-C charging cable (100 cm) included
- charge level indicator
- protection class: IP65/IK05
- weight: 72 g

Product no. 77490017

**€ 29.50\***

instead of € 50.47



## Work light 13134

Small, rechargeable torch with high luminosity.

- with 300 lm (up to 500 lm in short boost mode) and range of 26 m
- 3 brightness levels: 100 % (300 lm), 30 % (100 lm), boost (500 lm)
- runtime up to 1.5 h (300 lm), 3 h (100 lm)
- with a useful magnet in the base and in the retaining clip for attaching to metal surfaces
- USB-C charging cable (100 cm) included
- charge level indicator
- protection class: IPX3/IK07
- weight: 35 g

Product no. 77490016

**€ 23.50\***

instead of € 39.07



## Torch 13132

Compact professional aluminium torch with a highly efficient reflector system.

- up to 130 lm and 75 m range
- for up to 4 hours of use
- sturdy aircraft-grade aluminium body
- with a practical clip and hand strap
- battery-operated, incl. 2 batteries AAA 1.5 V
- protection class: IP54
- weight: 55 g

Product no. 77490014

**€ 19.50\***

instead of € 31.28

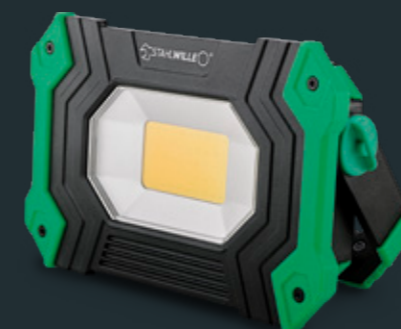

## Work spotlight 13133

Robust rechargeable work spotlight for professional use.

- up to 2,800 lm and 61 m range
- 3 brightness levels: 100 % (2,800 lm), 50 % (1,400 lm), 25 % (700 lm)
- 180° adjustable handle/carry handle
- runtime up to 3 h (2,800 lm), 7 h (1,400 lm), 13 h (700 lm)
- with a magnetic holder and a 360° rotating hanging hook

- sturdy plastic case with a rubberised edge
- USB-C charging cable (100 cm) included
- with power bank feature and charge level indicator
- protection class: IP64
- weight: 700 g

Product no. 77490015

**€ 74.90\***

instead of € 125.13



# SOCKET SET CASE – Flexible use: for reliable, efficient working.

## QR socket set case 1/2" + 1/4" 40/44/52/43/16QR

NEW

114-pcs. socket set 1/4"+1/2".

Comprehensive equipment, including 2 QuickRelease finetooth ratchets 1/2" and 1/4", extensions, universal joints, a variety of screwdriver, screwdriver bit and standard sockets (1/2" + 1/4"), 2 bit ratchet screwdrivers (1/4"), a drive handle (1/4"), a mini magnetic lifter, a bit box, and much more. In a plastic box.

Product no. 96031410

**€ 499.00\***

€ instead of € 1,097.00

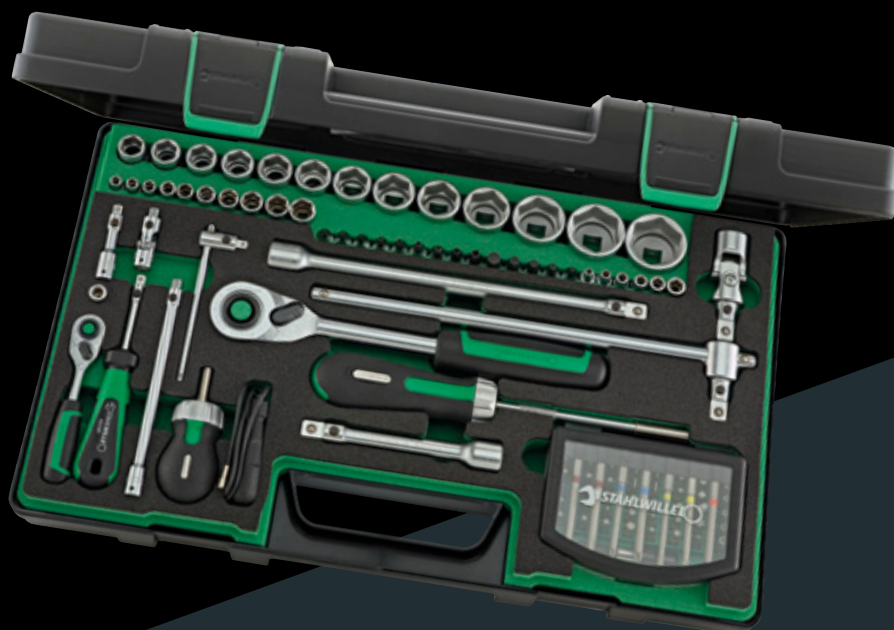

What's inside?

Find more details here:

[qr.stahlwille.com/zq7rc2](http://qr.stahlwille.com/zq7rc2)

Available from your STAHLWILLE dealer

STAHLWILLE sales office Austria and CEE countries · Puchgasse 1/1.07 · 1220 Wien · Österreich (Austria)  
Tel.: +43 1 6167616 · [info@stahlwille.de](mailto:info@stahlwille.de) · [www.stahlwille.com](http://www.stahlwille.com)

© STAHLWILLE Eduard Wille GmbH // 5-03-26 BMD // V 1.0 // 91970304

\*Recommended retail price, valid until 28.02.2027. Only for participating dealers and while stocks last.  
Subject to technical changes and errors. No liability for printing errors.

 STAHLWILLE®